

Data Sheet



Article number: 204250M1080D3S

Description: E+G levelling foot
GN 42-50-M10-80-D3-S

Note: S Without nut, External hexagon at the bottom

Measures

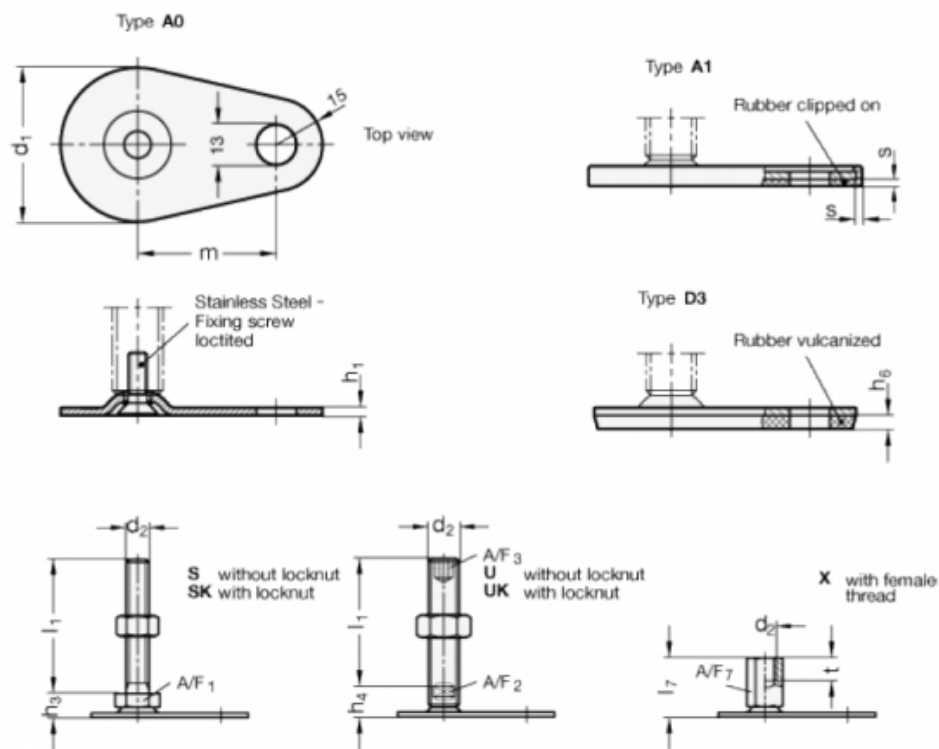

A/F1 = 17
d1 = 50
d2 = M10
h1 = 2.5
h3 = 11
h6 = 4
l1 = 80
m = 45

s =